

First, The outlines.

TM1804 is a three channels LED(light-emitting diode monitor)driving control dedicated circuit,it's inside intergrated with MCU digital interface 、 digital latch、 LED high voltage driving circuit and so on.Through the contoring of the outside MCU then the Chip ' single grey will be achieved.The cascade controlling make the outdoor big colored screen ' lattice come true.This product which is packaged by SOP8 has perfect performance and trustworthy quality .

Second, The characteristics

- With high voltage power CMOS crafts
- The withstanding voltage of output interface is 24v
- The working voltage of the chip is 5v-24v
- the grey calibration circuit(256 grade grey ajustment)
- serial interface cascade interface
- Vibration mode: RC inside vibrating and Clock synchronization according the signals from the date line.,after receiving all of the statistics from the unit then when finished the date shaping it can automatically send out through the ouput interface .
- power on reset inside
- PMW controlling side can make the 256 grade adjustment. Scanning frequency is more than 400hz/s
- It can make the datas' receiving the decoding come through one signal wire.
- When the refresh rate is 30 FPS the next cascade in low-speed mode is more than 512 spots,in the high –speed mode it is more than 1024 spots.
- Package type:SOP8
- Data sending speed can reach 400Kbps and 800Kbps separately two modes.

Third, The definition of the Pin

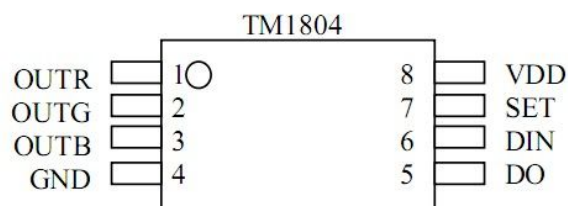

definition of Pin

symbol	Name of the PIN	Explanation
DIN	Data input	Display date input
DO	Data output	Display data cascade output
SET	Mode set	Connect VDD:low-speed mode;vacant;high-speed mode
OUTR	LED driving output	Red pwm controlling output
OUTG	LED driving output	Green PWM controlling output
OUTB	LED driving output	Blue PWM controlling output
VDD	Logic power	DC 5v±10%
GND	Logic ground	Connect grounding system

Limiting values (Ta=25°C, Vss=0V)

Parameter name	symbol	Range	Unit
Logic power voltage	VDD	-5.0~+7.0	v
input voltage range	Vin	-0.5~VDD+0.5	v
Port drive current	Iout	60	mA
Port drive pressure	Vout	-5.0~+30	v
Clock frequency	Fclk	800	KHz
Working temperature	Topr	-40~+85	°C
Storage temperature	Tstg	-55~+155	°C
Static electricity(ESD)	Human Body odel(HBM)	2000	v
	Mechanical mode(MM)	200	v

Recommended Working Conditions (Ta=-45~+85°C, Vss=0V)

Parameter name	symbol	Test condition	Min	Typical	Max	Unit
Logic power voltage	VDD		4.5	5.0	6.5	V
Port drive pressure	Vout				24.0	V
High level input voltage	VIH		3.8		VDD	V
Low level input voltage	VIL		GND		1.5	V
High level output current	Loh	VCC=5.0V,SDO=4.8V		1		mA
Low level output current	Lol	VCC=5.0V,SDO=0.5V		10		mA
Driver Port Sink Current	Lolc	OUTR,OUTG,OUTB=0.5V		40	45	mA

Working temperature	Ta		-40		+85	°C
Operating junction temperature	Tj		-40		+125	°C

Electrical Characteristics (Ta=-40~+85°C, VDD=3.0V~5.0V)

Parameter name	symbol	Test condition	Min	Typical	Max	Unit
High level output voltage	Voh	Voh=-6mA	VDD-0.5		VDD	V
Low level output voltage	Vol	Vol =10mA			0.5	V
Input current	Lin	DIN= Connect VDD or GND	-1		1	uA
VDD current	Idd	OUTR,OUTG,OUTB, DIN,DO= open circuit,VDD=5.0V	1	3	5	mA
Driver Port Sink Current	Iolc	OUTR,OUTG,OUTB, ON=0.5V		40	45	mA
Output leakage current	Iolk	OUTR,OUTG,OUTB= OFF			0.1	uA
Driver Port PWM cycle	Tpwm	OUT Connect 1K Pull-up resisto	3	3.5	4	ms
Dynamic current consumption	Idddyn	OUTR,OUTG,OUTB= OFF,DO= open circuit			1	mA
Thermal resistance	Rth(j-a)		79.2		190	°C/W
Power consumption	PD	Ts=25°C			250	mW
Drive port on-resistance	Ron	VDD=5.0V	13		14	Ω

Switching characteristics (Ta=-40~+85°C, VDD=3.0~5.5V)

Parameter name	symbols	Testing conditon	Min	Typical	Max	Unit
Low-speed mode	Fc1			400		KHz

High-speed mode	Fc2			400		KHz
Propagation Delay	TD	DIN→DOUT			300	ns
Fall time	Th1	CL=300pF, OUTR/OUTG/OUTB			120	us
Input capacitance	CI	-			15	pF-

Sixth,Function description:

This kind chip use single wire communication , it send signals through the method of return to zero. After The chip is in power on reset, it accept the data which the DIN end transferred.After I received full 24bit,DO interface start to forward the data and supply the input data for the next chip.Before forwarding the data,DO side always down.At this time the chip will not accept the new data, According the receiving 24bit signals ,OUTR、OUTG and OUTB these three PWM output in the chip will make corresponding different the space ratio signals,the cycle of this kind signals is 4ms.If the DIN side 'input signal is RESET signal the chip will receiving the display of the data transformation and it will accept the new data after the signal finished.after fully receiving the 24bit data,it will forward the data through the DO mouth.Before the chip accepting the RESTT Code, the original output of OUTR、OUTG、OUTB pin will not change,After accepting low level RESET code which more than 10Us,the chip will transfer the 24bit PWM data clock to the OUTR、OUTG、OUTB pin.

The chip is use the automatic shaping technology which make the quantity cascade will not be limited by the signal transferring only limited by the refresh rate frequency requirement.Such as :If we design one 1024 cascade,it refresh screen will use $1024*0.4*0.2=0.8192ms$ (The chip data delayed time is 0.4us),it will not flicker.

Seventh,Timing waveforms:

Input pattern:

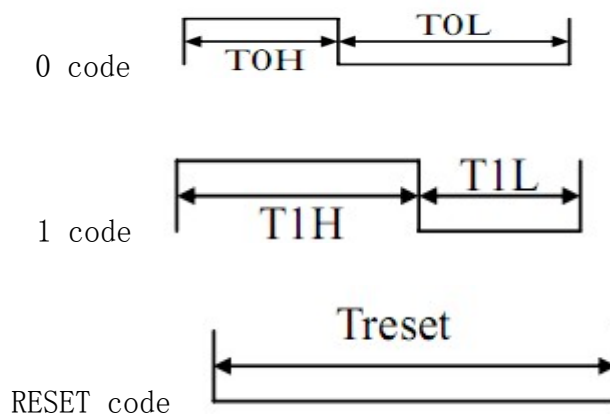

Low-speed mode time:

Name	Description	Testing condition	Min	TYP	Max	Unit
T0H	0 Code,high level time	VDD= 5V,GND =0V	500	700	900	ns
T1H	1 code, high level time		1600	1800	2000	ns
T0H'	0 code, high level time			700		ns
T1H'	1 code, high level time			1300		ns
T	0 code or 1 code cycle time				2.5	uS
Treset	Reset code, ,low level time			10	24	

Note:The cycle time of send 1 mode or 2 mode is 2.5uS (Frequency: 400KHz)

High-speed mode time:

Name	Description	Testing condition	Min	TYP	Max	Unit
T0H	0 Code,high level time	VDD= 5V,GND =0V	350	400	450	ns
T1H	1 code, high level time		700	850	1000	ns
T0H'	0 code, high level time			320		ns
T1H'	1 code, high level time			700		ns
T	0 code or 1 code cycle time				1.25	uS
Treset	Reset code, ,low level time			10	24	

Note:The cycle time of send 1 mode or 2 mode is 2.5uS (Frequency: 800KHz)

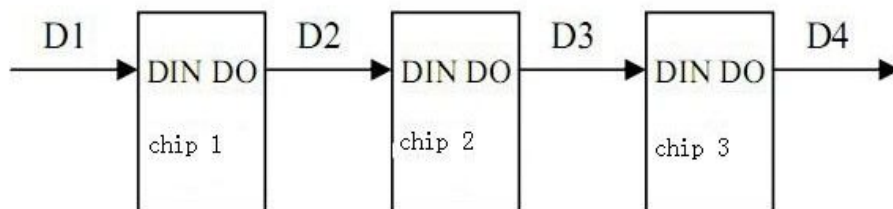

The data transferring method

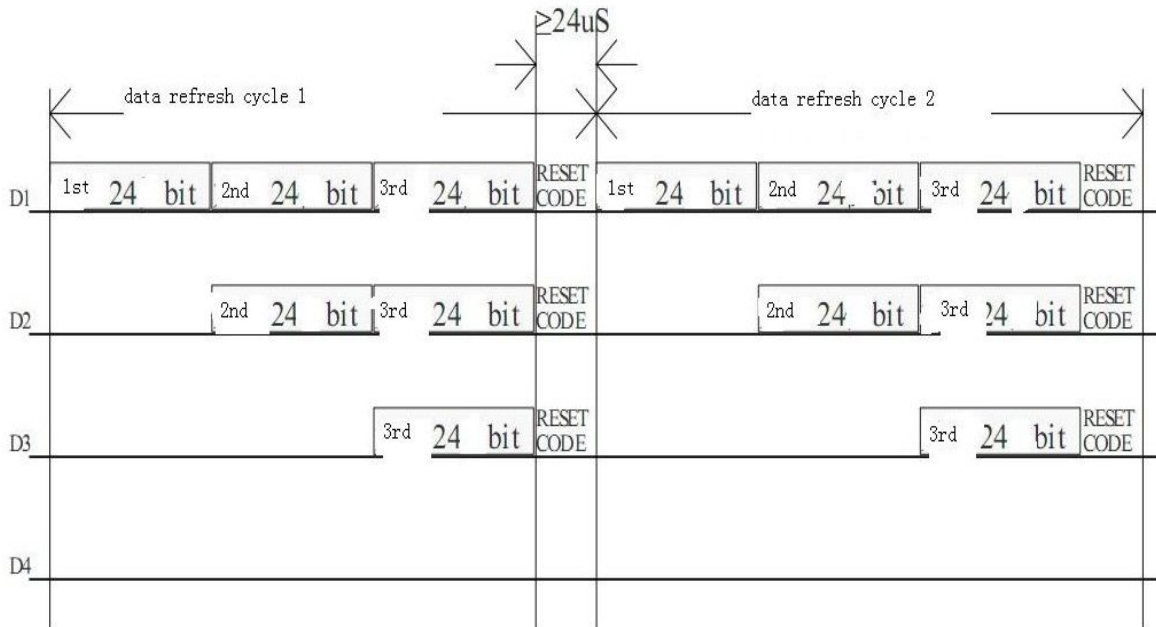

Note: D1 send data for MCU side, D2、D3、D4 forward the data for automatically shaping of cascade TM1804.

Data structure of 24Bit

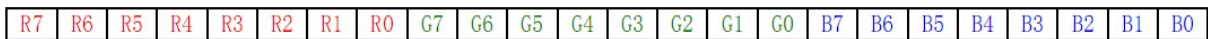

The high level sends first, according the turn of RGB it sends data.

Eighth, Application circuit and power configuration

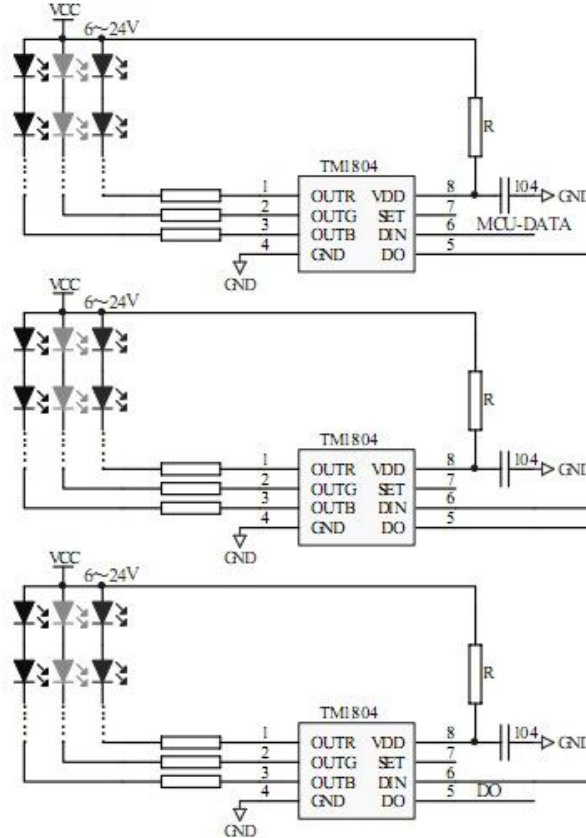

The TM1804 can configure to 6-24V Voltage for power supply, but according to the input voltage is different, it should configure different power resistors, the resistance is as follows:

Power voltage	Resistor connected between the power and the VDD
6V	330 Ω
9V	1.2K
12V	2.4K
24V	6.8K

In the real application, the voltage of VDD is about 5V, when the SET end is connected to high, it should connect to VDD, connecting to external power VDD is not accepted, it is proof of chip breakdown.

Ninth, the photos of the IC package

Sop8:

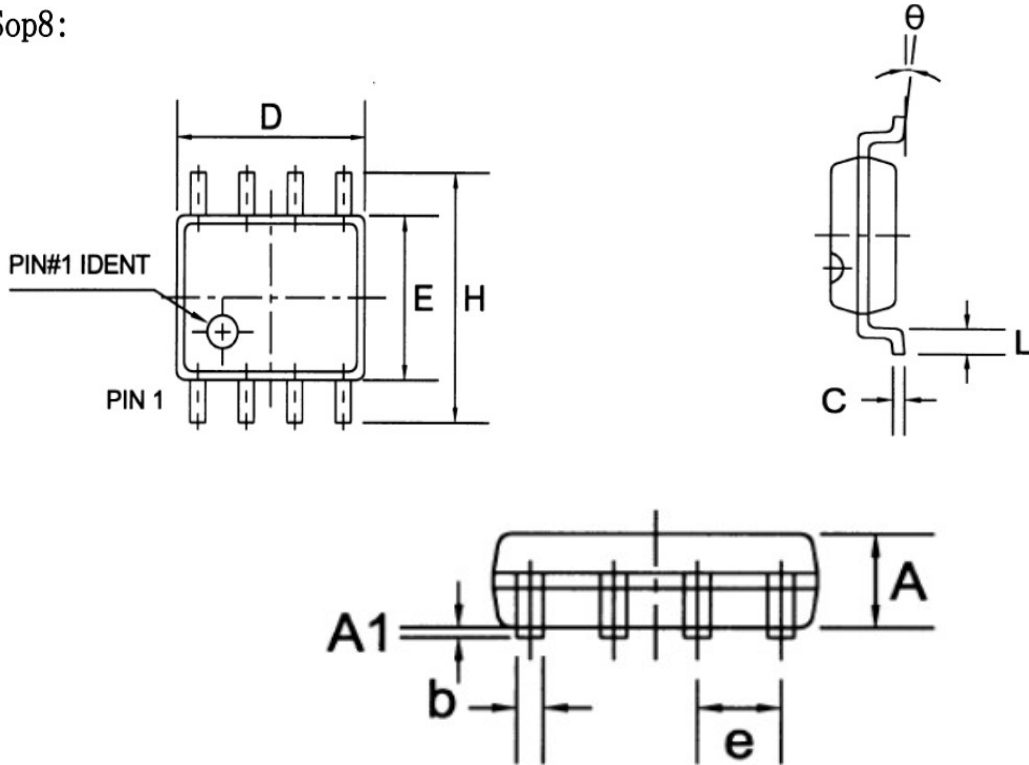

Mark	Inch			Millimeter		
	Min	Typ	Max	Min	Typ	Max
A	0.051	0.059	0.067	1.30	1.50	1.70
A1	0.002	0.006	0.010	0.06	0.16	0.26
b	0.012	0.016	0.022	0.30	0.40	0.55
c	0.006	0.010	0.014	0.15	0.25	0.35
D	0.186	0.194	0.202	4.72	4.92	5.12
E	0.148	0.156	0.163	3.75	3.95	4.15
e		0.050			1.27	
H	0.224	0.236	0.248	5.70	6.00	6.30
L	0.018	0.026	0.033	0.45	0.65	0.85
a	0°		8°	0°		8°